

**Digital Satellite Receiver
CryptoWorks Embedded**

DT 9500 CI

User's Manual



The product image may differ from the actual product.

Notice

Thank you for purchasing a HUMAX product. Please read this user manual carefully, to be able to safely install, use and maintain the product at maximum performance. Keep this user manual next to your product for future reference.

Throughout the whole manual, **Note** indicates additional product operation information to make the user aware of possible problems and information of any importance to help the user understand, use and maintain the installation.

Manufactured under license from Dolby Laboratories.

Dolby and the double-D symbol are trademarks of Dolby Laboratories.

All other trademarks are the properties of their respective owners.

Copyright © 2006 HUMAX Corporation

Not to be copied, used or translated in part or whole without HUMAX's prior consent in writing except approval of ownership of copyright and copyright law.

The information in this document is subject to change without notice.

Safety Warning

The product has been manufactured to satisfy international safety standards. Please read the following safety precautions and warnings carefully.

- Disconnect the product from the mains before you start any maintenance or installation procedures.
- Do not overload a wall outlet, extension cord or adapter as this may result in electric fire or shock.
- The product should not be exposed to liquid of any kind. In addition, no objects filled with liquid, such as vases, should be placed on the apparatus.
- Do not stand the product on soft furnishings or carpets. Do not stack electronic equipments on top of the product.
- Do not use any unsupported attachments as these may be hazardous or cause damage to the product.
- Disconnect the product from the mains before connecting or disconnecting the cable from the antenna or TV.
- The LNB cable must be earthed to the system earth for the satellite dish.
- Place the product indoors to avoid exposing it to lightening, rain or sun. Do not place it near a radiator or heat register. Make sure it has more than 10 cm clearance from any appliances susceptible to electromagnetic influences, such as a TV or a VCR. Do not block these openings with any object, and do not place the product on a bed, sofa, rug or other similar surface. If you place the product on a rack or bookcase, ensure that there is adequate ventilation and that you have followed the manufacturer's instructions for mounting.
Do not place the product on an unstable cart, stand, tripod, bracket or table where it can fall. A falling product can cause serious injury to a child or adult, and serious damage to the appliance.
- Unplug the product from the wall outlet and disconnect the antenna during a thunderstorm or when left unattended and unused for long periods of time.
- Do not insert anything through the openings in the unit, where they can touch dangerous voltage points or damage parts.
- When replacement parts are required, be sure the service technician uses replacement parts specified by the manufacturer or those that have the same characteristics as the original part. Unauthorised substitution may result in additional damage to the unit.

Contents

1. Before Using the Product	GB5
1.1 Package Contents	GB5
1.2 Front Panel	GB6
1.3 Rear Panel	GB7
1.4 Conditional Access	GB8
1.5 Remote Control	GB10
2. Setup	GB12
2.1 Connecting Antenna/TV/VCR	GB12
2.2 Connecting Audio System	GB15
2.3 Powering On	GB16
3. Basic Operation	GB17
3.1 Installation Wizard	GB17
3.2 Viewing Programme	GB18
3.3 Subtitle	GB19
3.4 Soundtrack	GB19
3.5 Teletext	GB20
4. Menu Map	GB21
5. Installation	GB23
5.1 DIGITURK	GB23
5.2 Advanced Installation	GB24
5.3 Organise Channels	GB29
5.4 Factory Settings	GB32
6. System Settings	GB33
6.1 Language Setting	GB33
6.2 Time and Date Setting	GB33
6.3 A/V Output Setting	GB34
6.4 UHF Tuning	GB34
6.5 Other Setting	GB35
6.6 System Information	GB36

Contents

7. Parental Control	GB37
7.1 Parental Rating	GB37
7.2 Modify PIN code	GB37
7.3 Front Panel Lock	GB37
8. Channel List	GB38
8.1 Switching Channels	GB38
8.2 Setting Property of Channel	GB39
8.3 Favourite List	GB40
9. Utility	GB41
10. Programme Guide	GB42
11. Mail	GB44
12. Conditional Access	GB45
13. Common Interface	GB46
14. Software Upgrade	GB47
14.1 OTA (Over the Air)	GB47
15. Troubleshooting	GB49
16. Specification	GB51

1. Before Using the Product

This chapter provides detailed instructions on the product and its accessories.

1.1 Package Contents

When you unpack your package contents, make sure you have all the necessary items shown in the figure below. If any of the items are missing or damaged, please contact your local product distributor for replacement.



Remote Control



Batteries



User's Manual



Warranty Card

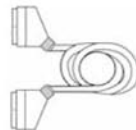

SCART Cable



RCA Cable



RF Cable

Note: The product image may differ from the actual product.

1. Before Using the Product

1.2 Front Panel

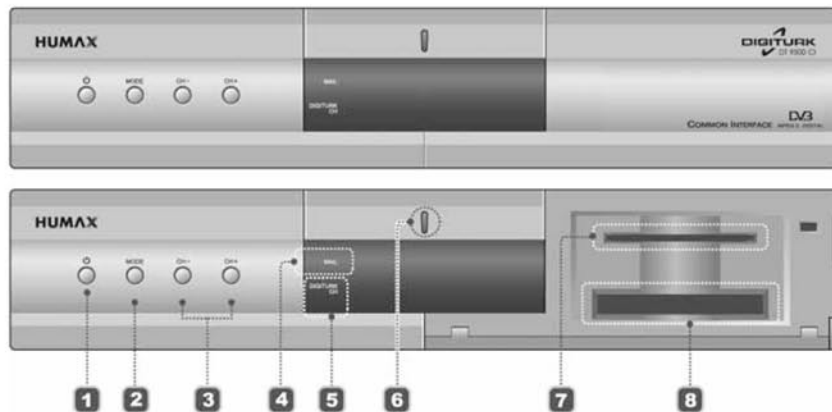

1. STANDBY Button

Switches between operation and standby modes.

2. MODE Button

Switches between DIGITURK and OTHER modes.

3. CH-/CH+ Button

Moves the TV/radio channel up/down.

4. MAIL LED

Green light is emitted when the mail was received.

5. DIGITURK CH LED

Amber light is emitted when viewing DIGITURK channel.

6. STANDBY LED

Red light is emitted when the product is in standby mode.

7. SMARTCARD SLOT

Slot for a Smartcard.

8. CI MODULE SLOT

Slot for a CI module.

Note: Refer to **1.4 Conditional Access** when you insert the Smartcard.

1.3 Rear Panel

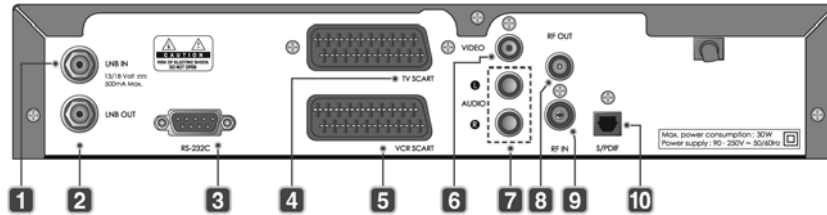

1. LNB IN

Connects to a satellite antenna cable.

2. LNB OUT

Connects to another digital Set-Top Box.

3. RS-232C

Connects to your PC to update software.

4. TV SCART

Connects a TV SCART cable.

5. VCR SCART

Connects a VCR SCART cable.

6. VIDEO

Connects to the TV or VCR and outputs video signals.

7. AUDIO L/R

Connects to the TV or VCR and outputs audio signals.

8. RF OUT

Connects the RF output jack of the product and the RF input jack on the TV with the RF cable. The default UHF channel is 36.

9. RF IN

Connects the general aerial antenna and the RF input jack of the product with the RF cable.

10. S/PDIF

Outputs digital audio signals (S/PDIF).

1. Before Using the Product

1.4 Conditional Access

Although some TV and radio channels are free to air, most TV and radio/music channels are available on a subscription basis and can only be enjoyed via Conditional Access component.

1. Inserting Smartcard

A Smartcard looks similar to a credit card and entitles you to view and listen to all the channels you choose to subscribe to. The Smartcard slot on the product can be used for CryptoWorks Smartcard only.

1. Open the right-hand flap on the front panel of the product.
2. Hold the Smartcard horizontally with the electronic chip (small squared-shape, gold in colour) facing upwards.
3. Insert the Smartcard into the top slot.

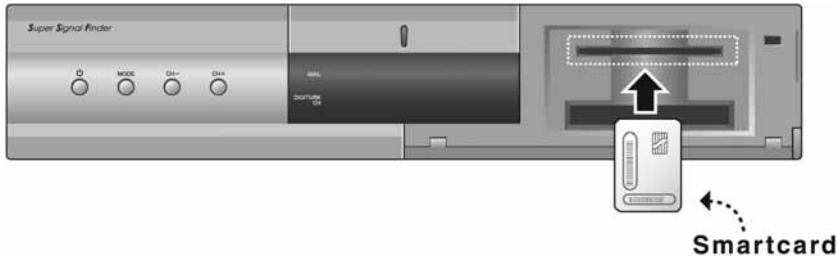

2. Inserting CI (Common Interface) Module

Your product is equipped with a slot for Common Interface (CI).

1. Open the right-hand flap on the front panel of the product.
2. Insert the Smartcard into the CI module, and the CI module into the slot.

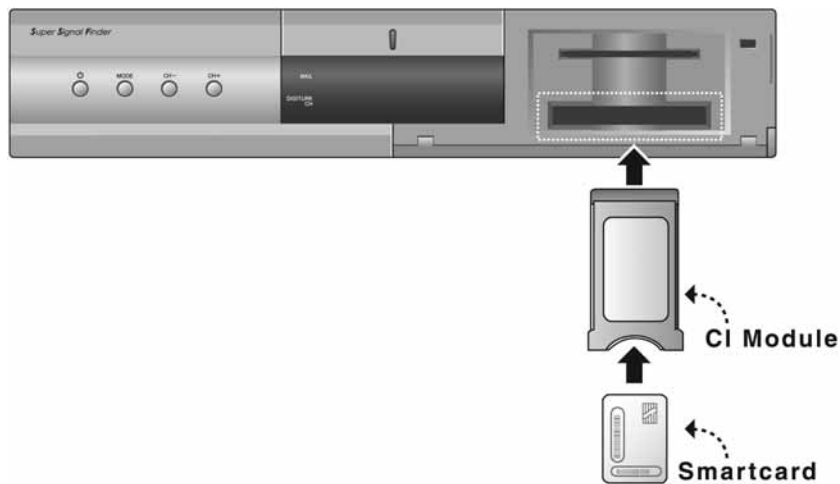

1. Before Using the Product

1.5 Remote Control

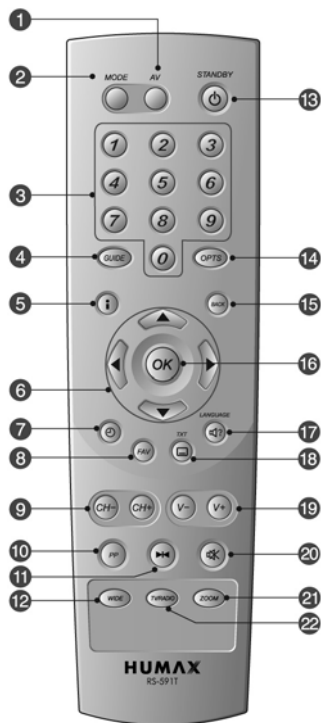

1. AV

Selects the input source between TV and the product.

2. MODE

Switches between DIGITURK and OTHER modes.

3. NUMERIC BUTTONS

Enter a TV/radio channel number.

4. GUIDE (EPG)

Displays the programme guide.

5. i (INFORMATION) - WHITE

Displays the information about the channel and programme.

6. ARROW BUTTONS

Changes channels or moves the cursor up, down, left or right in menu option.

7. TIME – RED

Displays the current time on the screen.

8. FAV (Favourite channel) – GREEN

Displays Favourite channel list.

9. CH-/CH+

Changes the channel.

10. PP (Recall)

Returns to the previous channel in each mode.

11. FREEZE

Freezes the scene you are watching. Does not cease audio.

12. WIDE

Changes the display format.

13. STANDBY

Switches between operation and standby modes.

14. OPTS

Displays the main menu.

15. BACK

Returns to the menu option.

16. OK

Selects a menu or confirms the selection. Displays the channel list while watching a programme.

17. LANGUAGE (SOUNDTRACK) – BLUE

Displays the a soundtrack list where available.

18. TXT (SUBTITLE) – YELLOW

Displays the subtitle language list where available.

19. V-/V+

Adjusts the audio volume.

20. MUTE

Mutes or unmutes the audio temporarily.

21. ZOOM

Enlarges the picture.

22. TV/RADIO

Switches between TV and radio. Does not work in DIGITURK mode.

**** COLOUR BUTTONS (R/G/B/Y/W)**

Select color keys for interactive applications.

2. Setup

This chapter describes how to set up the product. Select the most appropriate procedure depending on your requirements. Before you connect the product to any other equipment, you must disconnect all equipments from their power sources.

Note: If you encounter any problem when setting up the product, please contact your local product distributor.

2.1 Connecting Antenna/TV/VCR

1. Using SCART Cable

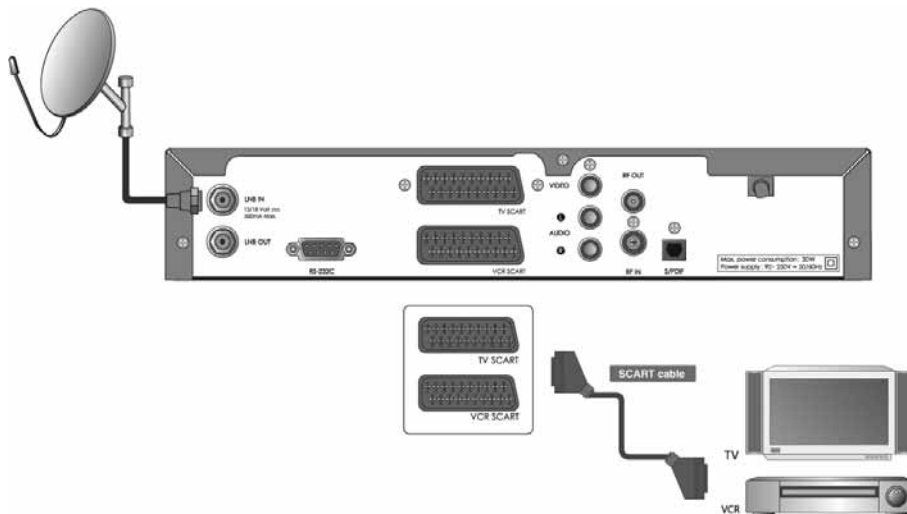

1. Connect the antenna to the LNB IN of the product.
2. The SCART cable is connected as in the figure above.

2. Using RCA Cable

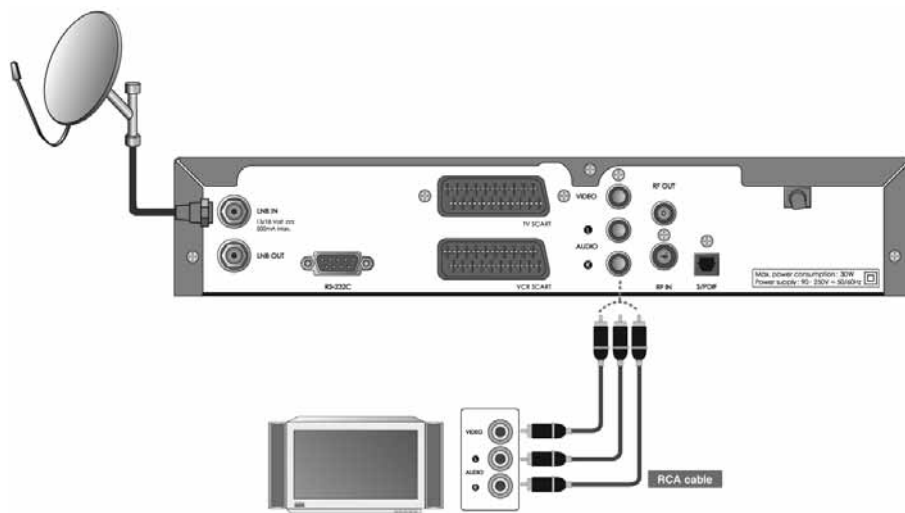

1. Connect the antenna to the LNB IN of the product.
2. The RCA cable is connected as in the figure above.

2. Setup

3. Using RF Cable

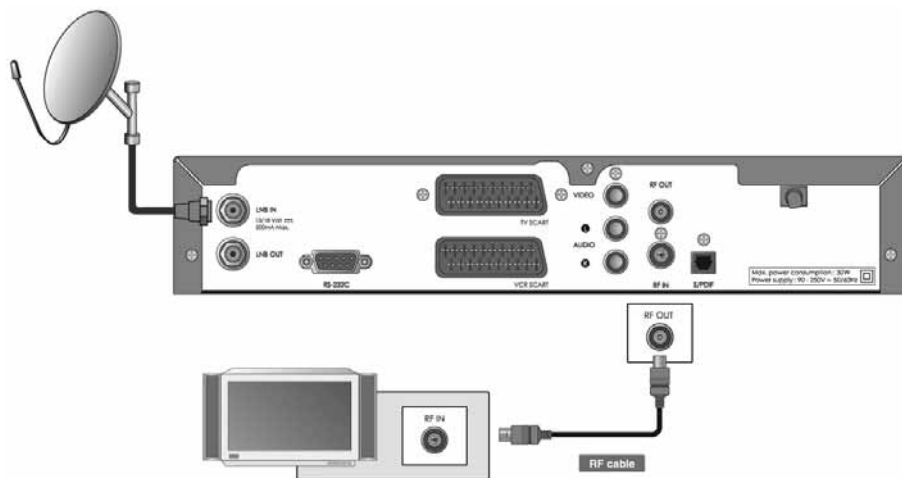

1. Connect the antenna to the LNB IN of the product.
2. The RF cable is connected as in the figure above.

Note: The default UHF channel is 36.

2.2 Connecting Audio System

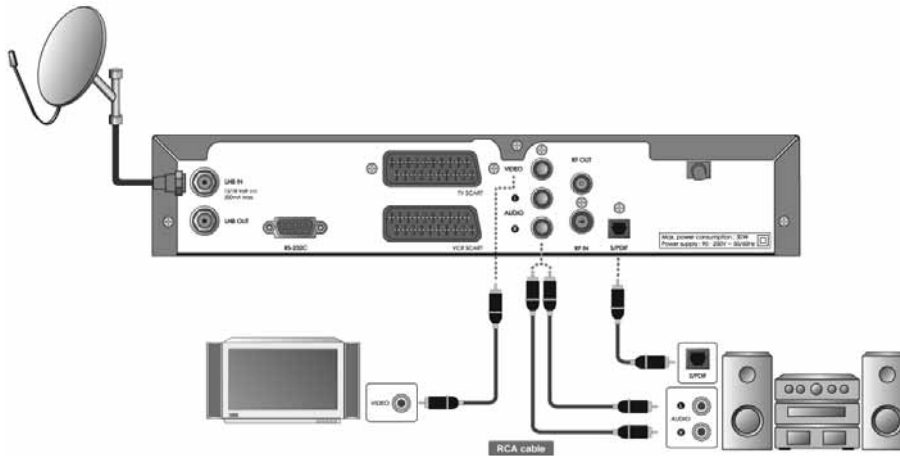

1. Connect the optical S/PDIF terminal and Dolby Digital decoder to listen to higher quality sound.
2. Connect VIDEO on the product and VIDEO IN on the TV using the RCA cable.
3. Connect AUDIO L/R on the product and AUDIO IN L/R on the audio system using the RCA cable.

2. Setup

2.3 Powering On

1. Connect the power cord of the product to a wall outlet.

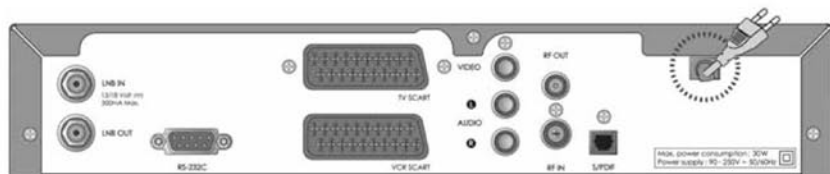

2. Press the **STANDBY** button on the front of the product or on the remote control.



3. Basic Operation

3.1 Installation Wizard

When powering on your product for the first time after purchase, the selecting country screen is automatically displayed.

Select the required country using the ▲/▼ button and press the **OK** button. If you select "Turkey", the **DIGITURK Installation** menu will be displayed. And if you select other countries, the **Advanced Installation** menu will be displayed.

Note: For detailed information about searching channels, refer to **5.1.1 DIGITURK Installation** and **5.2 Advanced Installation**.



3. Basic Operation

3.2 Viewing Programme

You can change the channel using the **CH-/CH+**, **▲/▼** or **NUMERIC** buttons. You can also use the Channel List or Programme Guide. You can adjust the audio volume using the **V-/V+** or **◀/▶** button.

Banner (Programme Information)

The banner is always displayed for a specific period of time whenever you switch channels. You can view the programme information by pressing the **i** button while watching a programme. You can see the detailed information about the current programme by pressing the **i** button twice. If the detailed information is more than one page, use the **▲/▼** button to move to the previous or next page. Press the **BACK** button to hide the banner. You can adjust the display time of banner in **MENU-System Settings-Other Setting-Banner Duration**.



- | | | | |
|--|--|--|--|
| | Represents parental level. Indicates the minimum level of ages that the programme is targeted at. | | Displayed only when the channel is a scrambled channel. |
| | Displayed only the programme is reserved. | | Displayed only when subtitle information is available. |
| | Displayed only when the channel is a locked channel. | | Displayed only when there is any teletext information. |
| | The channel group the programme is included in. Moves to the channels within the group when the channel is switched. | | Displayed only when the programme is broadcast in Dolby Digital. |

3.3 Subtitle

If the current programme provides subtitle information, the subtitle icon will appear on the banner. You can select the language for the subtitle using the **TEXT (SUBTITLE)** button. You can select a default subtitle language in **MENU-System Settings-Language Setting-Subtitle Language**.

3.4 Soundtrack





If the current programme is available in multiple audio languages, you can select the language that you wish to listen in using the **LANGUAGE (SOUNDTRACK)** button. You can select the default audio language in **MENU-System Settings-Language Setting-Audio Language**.



3. Basic Operation

3.5 Teletext

When the channel supports teletext, the teletext icon  is displayed on the banner. To enter Teletext mode, use the **TXT (SUBTITLE)** button to display teletext.

To display teletext menu, press the **OPTS** button in teletext mode. Select your desired teletext function using the /  button and press the **OK** button. To view the teletext page, use the **CH-/CH+**, , , **PP** or **NUMERIC** buttons.

4. Menu Map

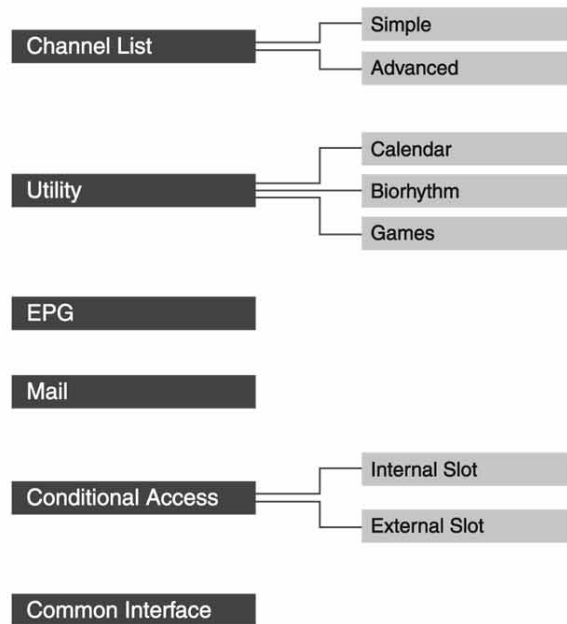
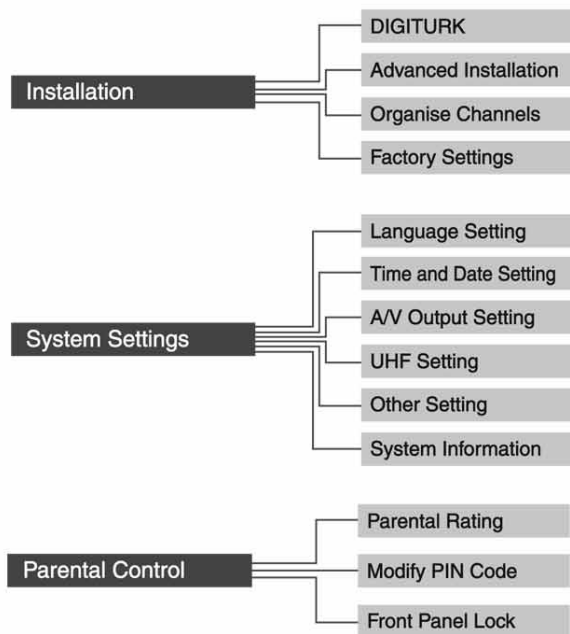

4. Menu Map

Menu structure varies according to the item and its operation. You can easily navigate the menu using the following instructions:

1. Press the **OPTS** button to display the main menu screen.
2. Select the item you want using the ▲/▼ button.
3. Press the **OK** button to move from a menu to a sub-menu.
4. Press the ◀/▶ button to select option values.
5. Press the **NUMERIC** buttons to enter the option values.
6. Press the **BACK** button to return to the parent-menu.
7. Press the **OPTS** button to exit the menu screen.

Note: Some menu items are access controlled. When accessing to the protected menu, you will be prompted to enter the PIN code. Enter the PIN code using the **NUMERIC** buttons. **The default PIN code is set to "0000".**

5. Installation

5.1 DIGITURK

1. DIGITURK Installation

You can automatically search the channel without entering any other information.

2. Change CAS Slot of All DIGITURK Channels

You can check the CAS slot currently in use and change the CAS slot of all **DIGITURK** channels. Select the CAS slot you want using the ▲/▼ button and press the **OK** button.



5. Installation

5.2 Advanced Installation

You can search other channels except **DIGITURK** channel.

Enter the PIN code using the **NUMERIC** buttons. **The default PIN code is set to "0000"**.

1. Antenna Setting

You can set antenna and LNB information to search channels using **Antenna Setting (MENU-Installation-Advanced Installation-Antenna Setting)**.

- **Antenna Alternative:** Select antenna alternative which has different combinations of settings for search. Antenna Alternative 16 is predefined for SMATV.
- **Satellite Name:** Displays the satellite list in name order. If the desired satellite name is not listed, then select "User Defined". You can enter the Satellite Name using the keyboard displayed on the screen.
- **LNB Frequency:** Select the L.O (Local Oscillator) Frequency of the LNB.
- **22KHz Tone:** When using the 22HKz tone switch, select "Enabled". Otherwise, select "Disabled".
- **DiSEqC Input:** If you are using DiSEqC (Digital Satellite Equipment Control) switch to connect multiple antennas or LNBs, select DiSEqC input to connect to antenna or LNB.
- **Motorised System:** When using motorised system, select "Enabled". Otherwise, select "Disabled". When Motorised System is set to "Enabled" DiSEqC Input is disabled.
- **LNB Voltage:** You can select "Standard" voltage or "High" voltage.
- **LNB Power:** You can select "On" or "Off".

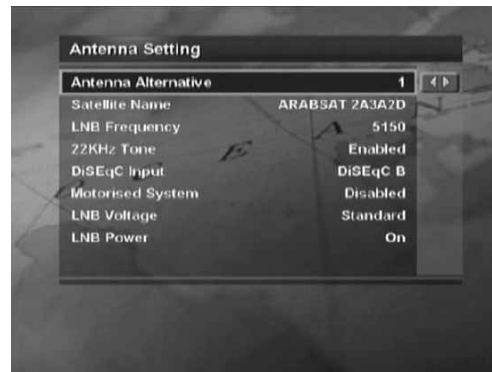

When you complete the settings, press the **OK** button to move to the **Manual Search** menu.

2. Manual Search

You can search channels of the selected satellite by transponders using the transponder information.

- **Antenna Alternative:** Select antenna alternative which has different combinations of settings for search. Antenna Alternative 16 is predefined for SMATV.
- **Frequency:** Enter transponder frequency.
- **Polarisation:** Select the type of polarisation.
- **Symbol Rate:** Select or enter transponder symbol rate.
- **FEC:** Select FEC (Forward Error Correction).
- **Network Search:** If you want to search channels for multiple transponders, select "Yes". Otherwise, select "No".
- **Automatic Skip:** When skipping all scrambled channel search, select "Yes". Otherwise, select "No".
- **Advanced:** In advanced mode, enter Video Packet ID (PID), Audio PID, and PCR PID.

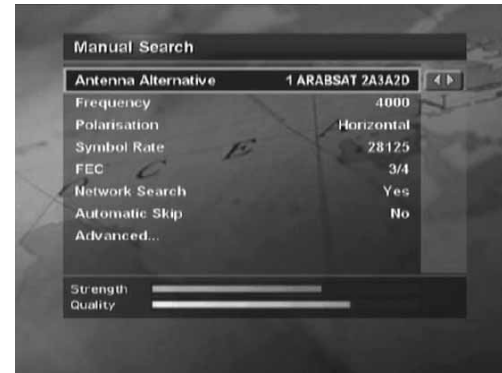

After setting the parameters of search, press the **OK** button to start channel search. Wait until the operation is completed. After finishing search operation, the result window will be displayed. You can delete the channels using the **▲/▼/◀/▶** and the **RED** button. To cancel deleting operation, press the **RED** button again. The screen also shows the number of the channels found and the transponder information.

To save the found channels, press the **OK** button.

Note:

- If the antenna is properly set up, the signal strength bar and quality bar level, located at the bottom of the screen moves up.
- Press the **BACK** button to stop search.

5. Installation

3. Satellite Setting

This menu appears only when you enable **Motorised System** in **Antenna Setting** menu and press the **OK** button while **Antenna Alternative** in **Manual Search** menu is selected.

- **Satellite Name:** Select a satellite to identify a motor antenna. If the desired satellite name is not listed, then select "other".
- **Movement:** In user mode, this is used to fine-tune the position of the motor. In installer mode, this is used to search for the position of the satellite manually.
- **Motor Control:** You can select one option among "Search", "Go to", "Store" or "Reset".
 - Search: Searches for channels on the selected transponder.
 - Go to: Moves the motor to the saved position of the selected satellite.
 - Store: Saves the current position of the motor for the selected satellite.
 - Reset: Resets all saved positions of the motor relative to the 0 position. (Installer Mode Only)
- **DiSEqC Command Mode:** Select "Installer" or "User mode".

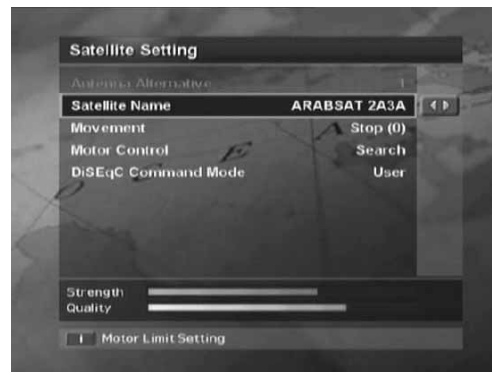

The following table shows the value of the motor setting options.

DiSEqC Command Mode	Movement	Motor Control
Installer	East / Stop / West	Search / Go to / Store / Reset
User	Stop(60E) ~Stop(0) ~Stop(60W)	Search / Go to / Store

To initialise the satellite position saved at **Motor Antenna**, set **DiSEqC Command Mode** to "Installer", set **Motor Control** to "Reset", then press the **OK** button. You will see a warning message. To continue the procedure, press the **OK** button.

To set the motor position for each satellite manually, select the **Satellite Name**, set **DiSEqC Command Mode** to "Installer", and then set **Movement** to one option among "East", "Stop" or "West". The motor starts moving. The level of signal strength and quality bar at the bottom of the screen will indicate the best position of the dish. Set **Motor Control** to "Store" when you find the best position, then press the **OK** button to save the position.

To move the motor to the pre-set position of the satellite, select the desired **Satellite Name**, set **DiSEqC Command Mode** to "User", set **Motor Control** to "Goto", and set **Movement** to the desired value. Movement is used to fine-tune the position of the motor. Press the **OK** button. The motor will move to the position of the selected satellite.

4. Motor Limit Setting

To enter this menu, press the **RED** button in **Satellite Setting** menu. You can set the maximum for both East and West to prevent damage to the antenna.

- **Limit Setting:** When **Limit setting** is set to "Enabled", the motor does not move exceeding the limit. When **Limit setting** is set to "Disabled", the setting is released.
- **Movement:** You can select one among "East", "Stop" or "West".
- **Store East Limit:** You can save the East Limit.
- **Store West Limit:** You can save the West Limit.



5. Installation

5. Automatic Search

If you select the satellite to search channels according to **Antenna Setting**, you can automatically search the channel without entering any other information.

To enter **Automatic Search** menu, press the **OPTS** button, then select **Installation-Advanced Installation-Automatic Search**.

- **Antenna Alternative:** Select antenna alternative which has different combinations of settings for search. The Satellite Name is automatically displayed. Antenna Alternative 16 is predefined for SMATV.
- **Automatic Skip:** When skipping all scrambled channel search, select "Yes". Otherwise, select "No".
- **Search Type:** If you want to search channels through all field of tuner (950~2150MHz), select "Manual". Otherwise, select "Auto" to search channels with the preset parameters. In detail mode, you can add the desired Symbol Rate.
- **Network Search:** If you want to search channels for multiple transponders, select "Yes". Otherwise, select "No". When you complete the setting, press the **OK** button to start channel search.



Note: Channels found during **Advanced Installation** menu shall be stored to the OTHER mode To switch between DIGITURK and OTHER channels press the **MODE** button on remote control.

5.3 Organise Channels

1. Organise All Channels

You can edit TV or radio channels using **Organise TV/Radio Channels** (*MENU-Installation-Organise Channels-Organise TV/Radio Channels-Organise All Channels*).

You will be prompted to enter the PIN code. **The default PIN code is "0000"**. Before leaving **Organise TV/Radio Channels** screen, you will be prompted to save the changes. If you would like to save the changes, select OK and press the **OK** button.

You can delete, move, lock or unlock, skip and rename channels. You can select a channel and press the **COLOUR** button to execute the corresponding operation as described on the screen.



When you rename a channel, the keyboard will appear on the screen. You can change the name using the keyboard. Select a character using the **▲/▼/◀/▶** button and press the **OK** button to enter the selected character. After entering the new name, press the **YELLOW** button to save it.

- To delete a character, press the **BLUE** button.
- To switch to the standard keyboard, press the **RED** button.
- To switch to the extended keyboard, press the **GREEN** button.

Note:

- You must enter the PIN code using the **NUMERIC** buttons to view the locked channels. **The default PIN code is set to "0000"**.
- You are not allowed to organize **DIGITURK** channels, except of lock feature.

5. Installation

2. Organise Favourite A~B

You can add channels to Favourite groups using **Organise Favourite TV/Radio Channels (MENU-Installation-Organise Channels-Organise TV/Radio Channels-Organise Favourite A~B)**. Before leaving **Organise Favourite TV/Radio Channels** screen, you will be prompted to save the changes. If you would like to save the changes, select OK and press the **OK** button.

The **Organise Favourite TV/Radio Channels** screen consists of Favourite Group and Favourite List on the left side of the screen and Channel List on the right side. You can move the highlighter in order of Favourite Group, Favourite List and Channel List using the **▶** button. You can move the highlighter in reverse direction using the **◀** button.

To add channels to Favourite List, select a channel in Channel List using the **▲/▼** button, and press the **OK** button.

For more information about how to edit the channels in Favourite List, refer to **5.3.1 Organise All Channels**.



3. Organise Satellites

You can delete satellites and transponders.

To enter **Organise Satellites** menu, go to **MENU-Installation-Organise Channels-Organise Satellites**.

The **Organise Satellites** screen consists of Satellite List on the left side of the screen and Transponder List and Channel List on the right side. You can move the highlighter in order of Satellite List, Transponder List and Channel List using the ► button. You can move the highlighter in reverse direction using the ◀ button.

You can select a satellite in Satellite List or transponder in Transponder List using the ▲/▼ button. Press the **RED** button to delete the selected satellite or transponder.



5. Installation

5.4 Factory Settings

You can restore the product to the factory settings using the **Factory Settings** menu (**MENU-Installation-Factory Settings**). You will be prompted to enter the PIN code. **The default PIN code is "0000"**.

For more information, refer to **5.1.1 DIGITURK Installation**.

Warning: Please note that once you perform the factory setting, all data except the customised PIN code will be restored to the factory settings.

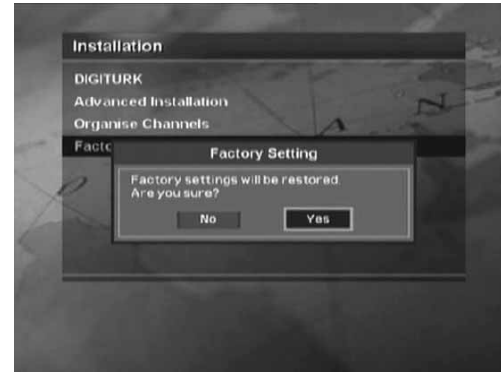

6. System Settings

The **System Settings** menu (*MENU-System Settings*) lets you customise your product according to your preference.

6.1 Language Setting

You can set the default language for menu, audio and subtitle.

6.2 Time and Date Setting

You can set the current time and turn the product on or off automatically. Once you set the Wakeup time and Sleep time, the product is turned on and off everyday.

Warning: When setting **Wakeup Channel No.**, press the **MODE** button to change the channel mode.

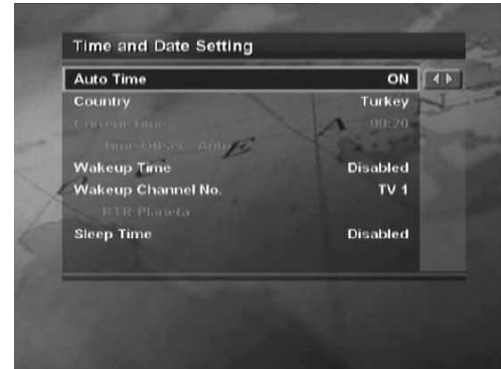

6. System Settings

6.3 A/V Output Setting

This menu lets you adjust the audio and video output, set Dolby Digital, match the screen ratio to your TV, select the display format according to the screen ratio, select the TV standard and set the NTSC mode.

Note: You can choose the Dolby Digital audio stream whenever possible by selecting "ON" in the **Dolby Digital** setting.

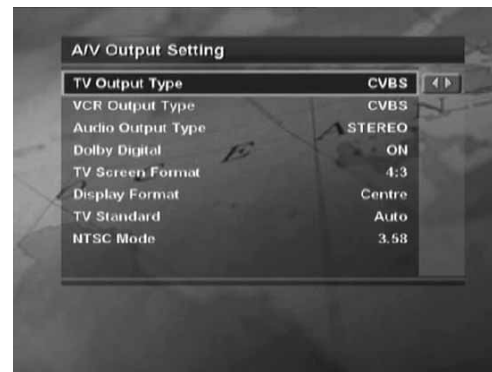

6.4 UHF Tuning

You can select UHF Channels for your TV and adjust fine tuning setting. The channel range and frequency change according to PAL Standard. The default UHF channel is 36.

6.5 Other Setting

You can adjust the transparency level of On-Screen Display (OSD), set the duration of the banner when switching channels, select automatic or manual mode for changing to reserved channel and set the duration of the reminder.

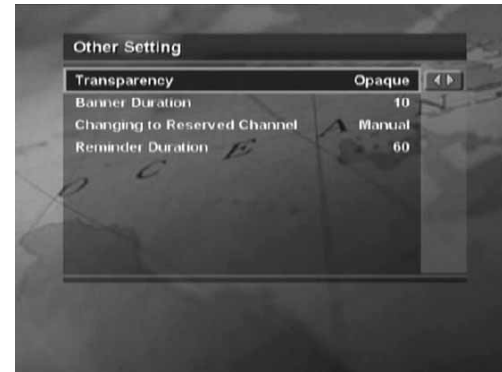

6. System Settings

6.6 System Information

The **System Information** menu (**MENU-System Settings-System Information**) provides information such as STB status, signal level of channel and software upgrade.

Note:

- You can also display **STB Status** by pressing **i** and **OK** button.
- For more information about software upgrade, refer to **14. Software Upgrade**.

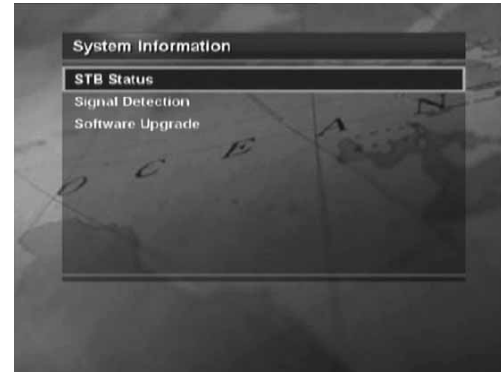

7. Parental Control

The **Parental Control** menu (*MENU-Parental Control*) lets you control the access to programmes by programme rating.

Note: Enter the PIN code using the **NUMERIC** buttons. **The default PIN code is set to "0000".**



7.1 Parental Rating

Set **Parental Rating** by age level. "no block" allows you to watch programmes without any blocking. You can block all programmes regardless of age level. The blocked programmes require the PIN code.

7.2 Modify PIN code

We recommend you to change the old PIN code to a new one periodically to ensure. If you have forgotten your PIN code, please contact your local product distributor. **The default PIN code is set to "0000".**

7.3 Front Panel Lock

You can lock the front panel. When setting "Lock", all buttons on the front panel except the **STANDBY** button do not work.

8. Channel List

There are five types of channel lists – All, Favourite, Network, Satellite, Alphabet - to find channels you are interested in quickly and easily. All channel lists display all searched TV or radio channels sorted by channel number. Favourite channel list displays favourite channels with three predefined sub-groups and two user defined sub-groups. Network channel list displays channels with several network subgroups. Satellite channel list displays channels classified by satellites. Alphabet channel list displays all searched TV or radio channels sorted by channel name.

8.1 Switching Channels

1. Press the **OK** button while watching a programme to display the channel list. You can also display the channel list using the **MENU-Channel List-Simple** (or **Advanced**).
2. Press the **COLOUR** button to display the corresponding channel list. **RED** (All channel list), **GREEN** (Favourite channel list), **YELLOW** (Network channel list), **BLUE** (Satellite channel list), **WHITE** (Alphabet channel list)
3. Select a channel using the **▲/▼**, **CH-/CH+** or **NUMERIC** buttons and press the **OK** button to change to the selected channel.

Note:

- Press the **MODE** button to switch between DIGITURK and OTHER channel list.
- Except in **DIGITURK** channel list, whenever you press the **TV/RADIO** button while the channel list is displayed, the channel list will be switched between TV and radio channel list.
- There are four user defined sub-groups (A~D) in DIGITURK Favourite channel list.



8.2 Setting Property of Channel

You can add the current channel to Favourite group. In addition, you can lock, unlock, skip or delete the current channel while watching a programme.

The operation is as follows:

1. Press the **OK** button while watching a programme. The channel list will appear on the screen. You can also display the channel list using the **MENU-Channel List-Simple** (or **Advanced**). You can select the type of the channel lists (All, Favourite, Network, Satellite, Alphabet) by pressing the **COLOUR** button.
2. Press the **OPTS** button while the channel list is displayed.
3. Select an option (**Favourites/Lock** or **Unlock/Skip/Delete**) using the **▲/▼** button and press the **OK** or **◀/▶** button.
4. After setting property of a channel, press the **OK** or **BACK** button to save the changes.



Note:

- There are two sub-groups in the TV and radio Favourite channel list.
- When unlocking a channel, you will be prompted to enter the PIN code. **The default PIN code is set to "0000"**.
- When switching to a locked channel, you must enter the PIN code to view the channel.
- You will not be able to watch skipped channels by using the **CH-/CH+** button. However, you can watch the skipped channels using the **NUMERIC** buttons or Channel List.
- For detailed information about how to register all channels as Favourite Channel, refer to **5.3.2 Organise Favourite A~B** and **8.3 Favourite List**.
- **Skip** and **Delete** are not available for DIGITURK channels.

8. Channel List

8.3 Favourite List

You can check and edit Favourite list quickly and easily.

1. Press the **FAV** button to display Favourite list while watching a programme.
2. Press the **RED** button to display the all channel list. Select the channel you want to add to Favourite list and press the **OK** button. Press the **BLUE** button to view the channel you select. To close the all channel list, press the **BACK** button.
3. Press the **GREEN** button while displaying Favourite list to switch between Favourite A and B.
4. Press the **YELLOW** button to move the channel to the location you want.



Note:

- Press the **MODE** button to switch between DIGITURK and OTHER channel list.
- There are four user defined sub-groups (A~D) in DIGITURK Favourite channel list.

9. Utility

The product provides various utilities: calendar, biorhythm and games. To use utilities, go to **MENU-UTILITY**.

1. Calendar

You can see the monthly calendar. Press the ▲/▼ button to change the year. Press the ◀/▶ button to change the month. Press the **OK** or **BACK** button to return to the previous menu.

2. Biorhythm

You can adjust your birth year and date to see your current biorhythm status. Press the ◀/▶ button to move to the next step. Press the ▲/▼ button to change a value in the step. Press the **BACK** button to return to the previous menu.

3. Games

You can select games using the ◀/▶ button. Use the ▲/▼/◀/▶, **OK**, **COLOUR** or **BACK** button according to the instructions displayed on the screen.

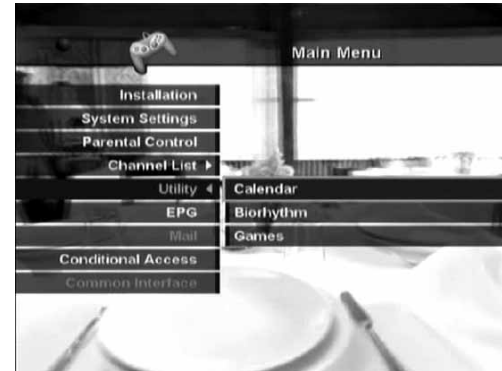

10. Programme Guide

The programme guide provides the programme information for all channels, based on date and time. In addition, it provides convenient ways to view programmes in "Now", "Next", "Weekly" or "Quick" mode - to search your desired programme and to watch or reserve it.

You can go to the programme guide screen by just pressing the **GUIDE** button or by using **MENU-EPG**. To close the guide screen, press the **GUIDE** or **BACK** button.

You can navigate the guide using the following instructions:

- Press the **RED** button to display the current or next programme list.
- Press the **GREEN** button to display the programme list for a week.
- Press the **YELLOW** button to display the reserved programme list.
- Press the **BLUE** button to display the simple Guide. This is also called Quick Guide.

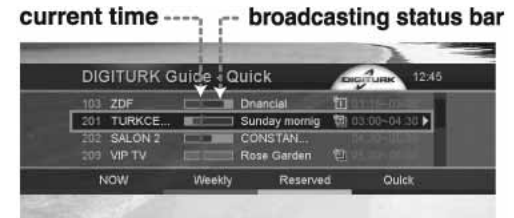



- Press the **WHITE** button to reserve the selected programme in "Now", "Next", "Weekly" or "Quick" mode.
- Press the **WHITE** button to change the reservation mode or to cancel the reservation in Reserved mode.
- Select a channel using the **▲/▼** or **CH-/CH+** button. When switching channels using the **▲/▼** button, press the **OK** button to display the selected channel on the right side of the screen.
- Select a day in "Weekly" mode using the **◀/▶** button, and press the **OK** button.



Note:

- Press the **TV/RADIO** button to switch to Radio Guide.
- The reservation icons on the reserved programmes in the guide differ according to the reservation type.

	Once	Reserve the programme once.
	Daily	Reserve the programme everyday.
	Weekly	Reserve the programme once a week.

- If the programme is overlapped with another programme, adjust the reservation appropriately. If the channel is locked, restricted by watching time, you will be prompted to enter your PIN code to complete the reservation.
- Press the **MODE** button to switch between **DIGITURK** and TV Guide.
- Press **i** button in the selected programme to view the detail information. And you can also make a reservation in the detail information screen.

11. Mail

You receive mails sent by broadcasting company. When a new mail arrives, the envelope icon will appear on the screen. Sometimes a new message will be directly displayed on the screen while you are watching a programme. The old mails will be deleted automatically when your mail box overflows. Select a mail using the ▲/▼ button, then press the **OK** button to read the mail. The message will be displayed. If you would like to delete the read mail, select **Delete**, and press the **OK** button.



12. Conditional Access

You can check the information of Internal or External Smartcard using the ***MENU-Conditional Access***.

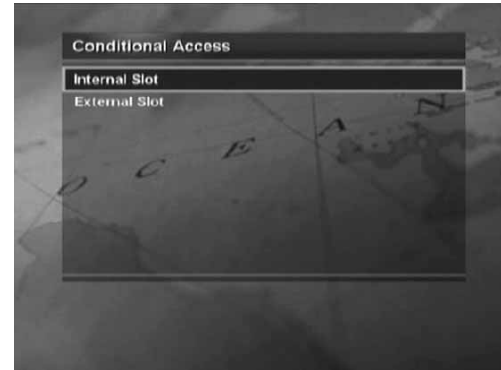

13. Common Interface

You can check the information of CI module using the ***MENU-Common Interface***.



14. Software Upgrade

In order to maintain proper performance of the product, it is essential to have the most up-to-date software.

14.1 OTA (Over the Air)

OTA, an abbreviation of **Over-the-Air**, is a standard for the transmission of software through a broadcast system.

OTA is simply an alternative method for downloading software versions. However, the manufacturers reserve the right for deciding the release of the software for their products by beaming the latest software versions over the air via satellite. Note that OTA is only limited to certain geographical regions mainly due to different antennas having different footprints(area where the signal can be received). The software update via satellite will only occur under the following circumstances.

1. The equipment should have appropriate loader software.

Caution: Please note that if normal loader software is not equipped, the product may not be updated or operate properly after software update.

2. The manufacturer decides to release the software via a designated satellite.
3. The equipment must be tuned properly to the same antenna equivalent to that of the manufacturer.
4. Update software when the signal strength and quality is high. If the weather is not favorable, and the signal strength and quality are not recommendable, perform the software update later.

Caution:

- Please be careful to keep the power on and the power cord plugged in during software update. If the power is off during software update, fatal damage may be caused to the product.
- Please be careful not to pull out the signal line (LNB cable) during software update. Update may be interrupted and the product may not operate.

Note

- Other functions will not activate while software update takes place.
- It may take 5 ~10 minutes to update software.
- Scheduling operation cannot work during software update.

14. Software Upgrade

Updating software is largely divided into two ways, automatic and manual search in ***MENU-System Settings-System Information-Software Upgrade***.

Select **Automatic Search** to search pre-defined DIGITURK TPs for new software automatically. When new software is available to download, the product will be automatically powered off and on.

If new software is not found by automatic update, use manual update.

For more information about how to set the manual search, refer to **5.2.2 Manual Search**.

15. Troubleshooting

Before contacting your local service, please read the following instructions. If the product does not work normally after completing the following troubleshooting, please contact your local product distributor or service centre.

1. **The LED on the front panel does not light.**

- Check the main power cable and make sure that it is plugged into a suitable power outlet.

2. **No picture**

- Make sure that the product is in operation mode.
- Make sure that the AV Cable is firmly connected to the TV.
- Make sure that the antenna line is correctly connected to the equipment.
- Check the brightness level of TV.
- Check if the channel is on air.

3. **Poor picture or sound quality**

- Make sure there is no mobile phone or microwave oven near the equipment.
- Check the signal strength and quality which can be influenced by weather.
- Change satellite dish into a bigger one if it is small.
- Replace the LNB with a one with low noise factor if the noise factor is high.
- Replace the LNB with a new one if it is damaged or out of order.

4. **No or poor sound**

- Check the volume level of the TV and product.
- Check the mute status of the TV and product.
- Press the **SOUNDTRACK** button to change the audio type.

15. Troubleshooting

5. Remote control does not operate

- To manipulate the equipment with the remote control, its emitting part should directly point towards its receiving part of the product.
- Check the battery of the remote control.

6. Reservation is unavailable

- Check if it is not overlapped with other reservation.
- Check if the power is off.

7. Watching scrambled channel is not available

- Make sure the correct Smartcard is plugged in.
- Make sure the Smartcard is correctly inserted, and insert the Smartcard again.
- Check if the Smartcard is damaged.
- Make sure you have subscribed to the channel.

16. Specification

MPEG Transport Stream A/V Decoding

Aspect Ratio	4:3, 16:9
Video Resolution	720 x 576, 720 x 480
Audio Mode	Single /Dual mono/ Stereo /Joint stereo

Memory

Flash Memory	2 Mbytes
Graphics(MPEG) & System Memory	16 Mbytes
EEPROM	8 Kbytes

RF-Modulator

Output Channel	CH 21 ~ 69
TV standard	PAL I/G/B/D/K
Preset Channel	CH 36

A/V & Data In/Out

TV SCART	Video Output (CVBS, RGB, S-Video) Audio Output
VCR SCART	Video Output (CVBS, S-Video) Video Input (CVBS, RGB, S-Video) Audio Output
S/PDIF	Digital Audio Output, Fiber-Optic (Resolution: 20 bits)

Power Supply

Input Voltage	AC 90 ~ 250V, 50/60Hz
Type	Switching Mode Power Supply (SMPS)
Power Consumption	Operation mode: Max. 30 W Standby mode: Max. 30 W
Protection	Separate internal fuse & Lightning protection

Physical Specification

Size	310 mm X 60 mm X 237 mm
Weight (Net)	1.8 kg
Operating Temperature	0 °C to +45 °C
Storage Humidity	5% ~ 95% RH (Non-condensing)